

**NEW!!!**

# ST 280 SURGE ARRESTER

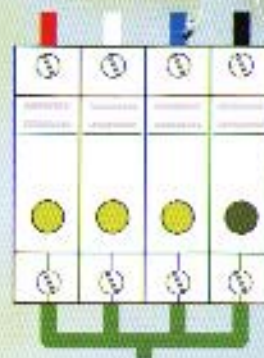

**UNSURE?**



## DON'T TAKE CHANCES ON *NEUTRAL* INDICATION *ELIMINATE DOUBTS AND GUESS WORK*

- No power required for fault indication
- DIN rail mounted
- Class 2 - maximum 25kA (8/20) surge arrester
- Can be used for live or neutral independently
- Complies with SABS 0142-1 and SABS IEC 61643-1
- Suitable for 230V - 440V power supply systems
- Competitively priced



*Fill in your CoC  
with confidence*





Technical Data

|                           |                       |                    |                    |
|---------------------------|-----------------------|--------------------|--------------------|
| $U_c$                     | 280 V~<br>350 V~      |                    |                    |
| min. $I_{n1}$             | 100 A gL/gG           |                    |                    |
| $\theta^{°C}$             | -40° C ... + 80° C    |                    |                    |
| IP-Code                   | 20                    |                    |                    |
|                           | Fine stranded<br>9 mm | Solid<br>9 mm      | Standard<br>9 mm   |
| min. $I_{n2}$<br>L, N, PE |                       | 6 mm <sup>2</sup>  |                    |
| max. $I_{n2}$<br>L, N, PE | 16 mm <sup>2</sup>    | 25 mm <sup>2</sup> | 16 mm <sup>2</sup> |

Backup Fuse

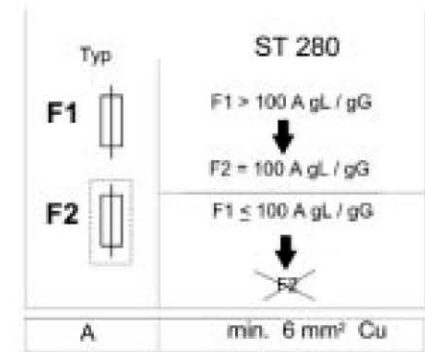

TN - C

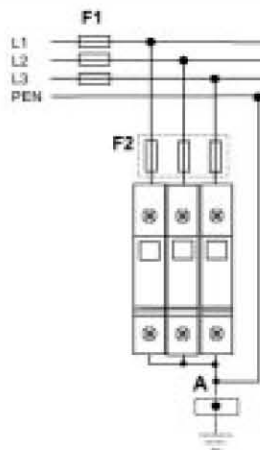

TN-C-S

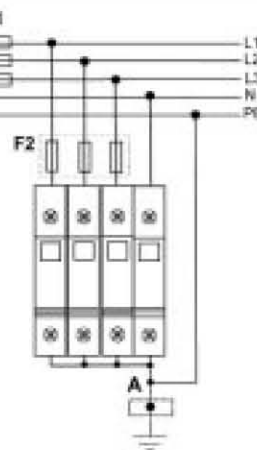

TN - S

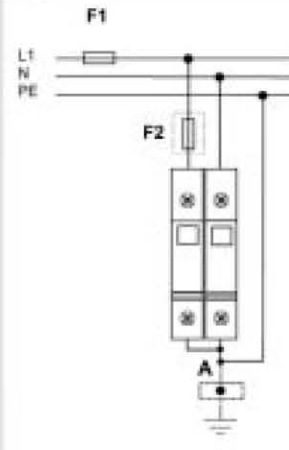

TN - S

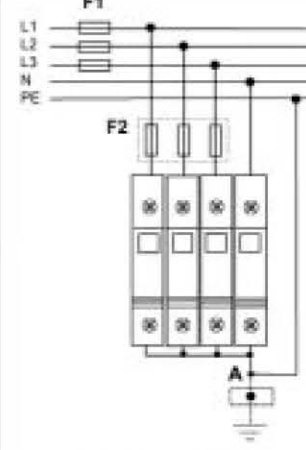

TT 3 + 1

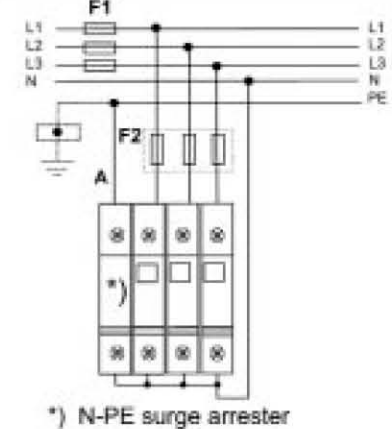

Fault Indication



Safety Instructions

This device may only be installed by a qualified person. National standards and safety regulations must be observed. The device must be checked for external damage prior to installation. If any damage or other defects are detected in this check, the device must not be installed. Its use only permitted within the limits shown and stated in these installation instructions. The device and the equipment connected to can be destroyed by loads exceeding the values stated. Opening or otherwise tampering with the device invalidates the warranty.



ST 280



white

→ o.k.



black



**COPA**